

tET/tPET SERIES QUICK START GUIDE

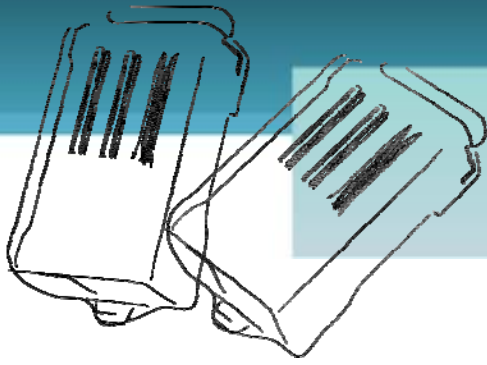

For tET-P2R2/tPET-P2R2

English/ December 2010/ Version 1.0

1 What's in the shipping package?

The package includes the following items:



**tET-P2R2 or
tPET-P2R2**



Software CD

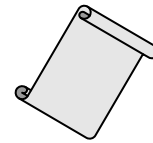

Quick Start Guide
(This Document)

2 Preparations for devices

1. Power Supply: **+12 ~ +48 Vdc**
2. Ethernet Hub. (PoE Ethernet Switch for tPET module only)
3. Make sure your PC has workable network settings.
4. Disable or well configure your Windows firewall and Anti-Virus firewall first, else the "**Search Servers**" on page 5 may not work. (Please contact with your system Administrator)

3 Connecting the Power and Host PC

1. Check Init/Normal switch is on "RUN" position.



2. Connect both the tET/tPET-P2R2 and your computer to the same sub network or the same Ethernet Switch, and power tET/tPET-P2R2 on.

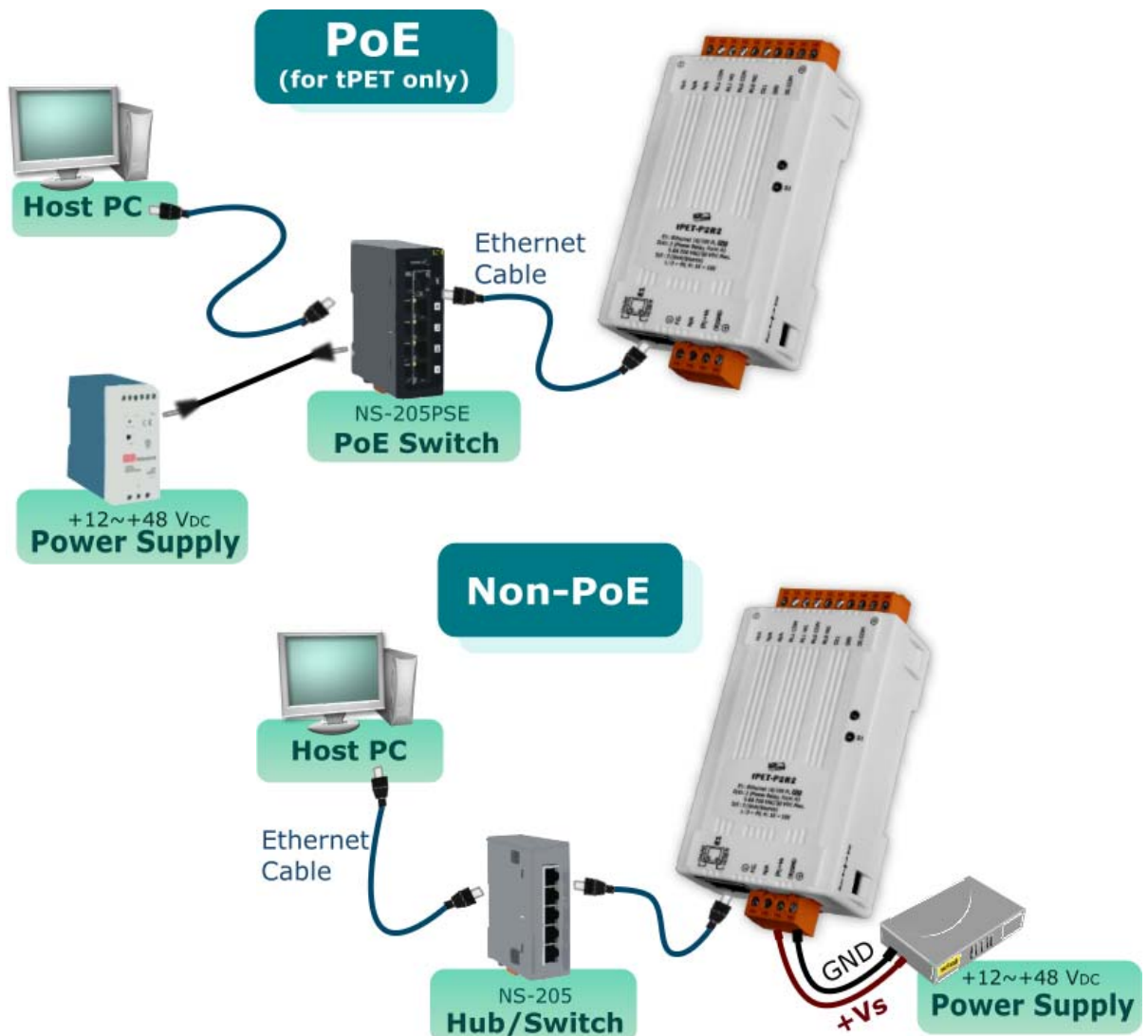

4

Pin Assignments and Wiring Note

Pin Assignments

Terminal No.	Pin Assignment
E1	Link/Act 10/100 M
01	F.G.
02	N/A
03	(R) +Vs
04	(B) GND

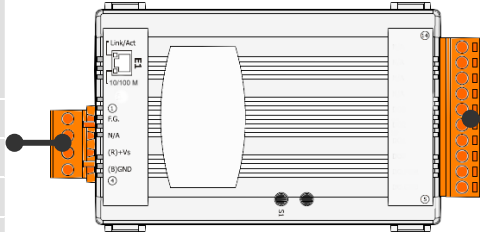

Terminal No.	Pin Assignment
14	N/A
13	N/A
12	N/A
11	RL1 COM
10	RL1 NO
09	RL0 COM
08	RL0 NO
07	DI1
06	DI0
05	DI.COM

Digital Input/Output Wiring

Digital Input	Readback as 1	Readback as 0
Sink	+10 ~ +50 V _{DC} 	OPEN or <4 V _{DC}
	Source	+10 ~ +50 V _{DC}

Digital Output	Readback as 1	Readback as 0
Relay Output	Relay On 	Relay Off

- Wire the DI and DO for self test. The wiring as follows:
 1. Connect the **RL0 COM** and **DI0**. (Pin09 connect to Pin06)
 2. Supply the **External Power +10V** to **RL0 NO**. (External +10V connect to Pin08)
 3. Supply the **External Power GND** to **DI.COM**. (External GND connect to Pin05)

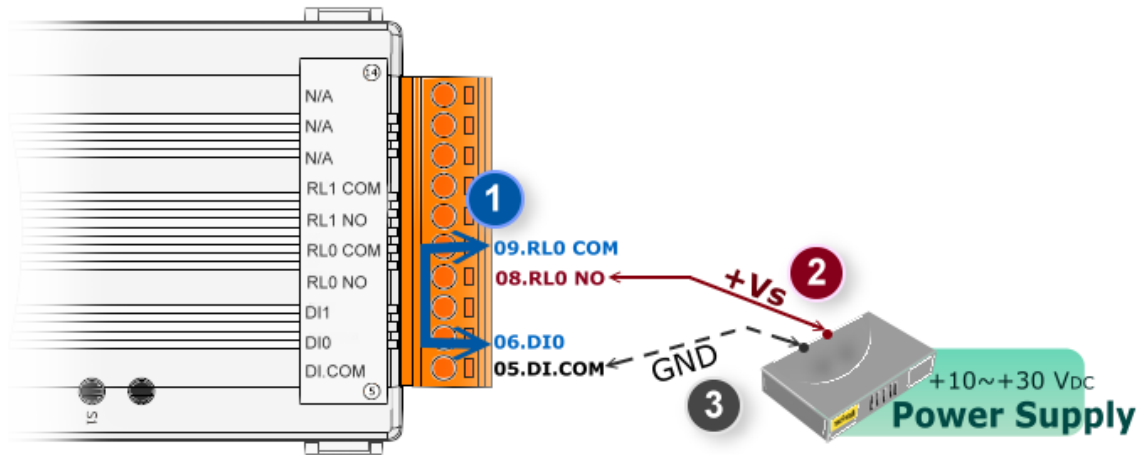

■ DI/DO Modbus Address

(1xxxx) DI address:

Begin address	Points	Description	Bits per Point	Range	Access Type
0 (0x0)	1~2	Digital Input	1	0: Off 1: On	R
32 (0x20)	1~2	Digital latched status (high)	1	0: no 1: latched	R
64 (0x40)	1~2	Digital latched status (low)	1	0: no 1: latched	R

(0xxxx) DO address:

Begin address	Points	Description	Bits per Point	Range	Access Type
0 (0x0)	1~2	Digital Output	1	0: Off 1: On	R/W
32 (0x20)	1	Clear all DI latched status (high)	1	1: Clear	W
33 (0x21)	1	Clear all DI latched status (low)	1	1: Clear	W
.
235 (0xEB)	1~2	Power-on value for DO	1	0=Off 1=On	R/W/F
267 (0x10B)	1~2	safe value for DO	1	0=Off 1=On	R/W/F

i For detail "DI/DO Modbus Address" information, please refer to section **5.3 Modbus Register Map** of user's manual. CD:\NAPDOS\TPET\Document\
<http://ftp.icpdas.com/pub/cd/tinymodules/napdos/tpet/document/>

5

Configuring Ethernet Settings

1. Run the eSearch Utility.

The eSearch Utility is located at:
CD:\Napdos\Software\eSearch\

<http://ftp.icpdas.com/pub/cd/tinymodules/napdos/software/esearch/>



2. Click "Search Servers" button to search your tET/tPET-P2R2.
3. Double-Click your tET/tPET-P2R2 to configure the settings.

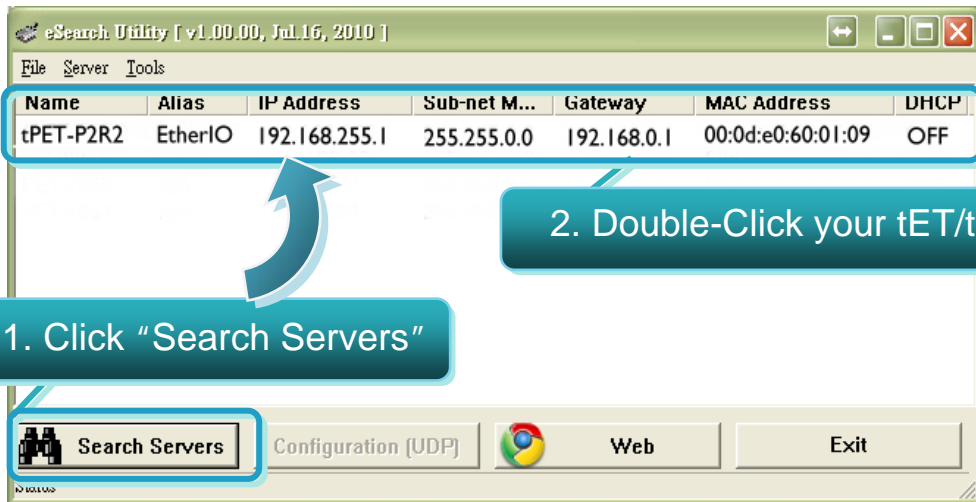

4. Contact your Network Administrator to get correct network configuration. Modify the network settings and then click "OK" button. The tET/tPET-P2R2 will restart it-self immediately.

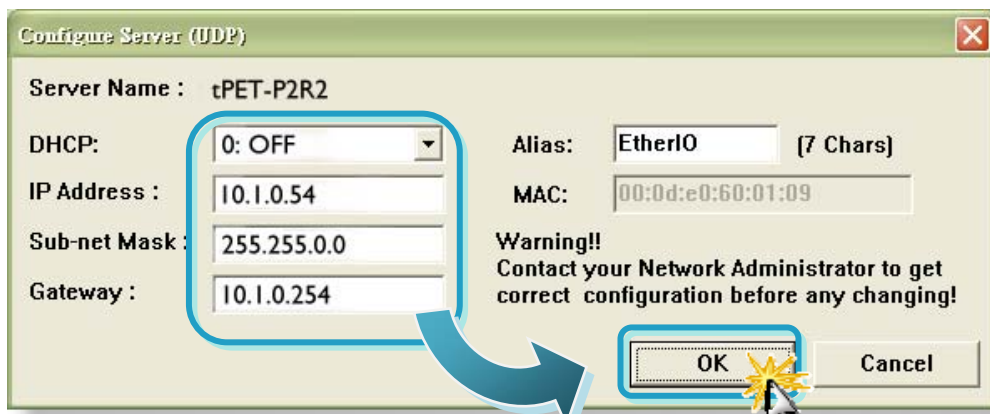

6 Testing your tET/tPET Module

1. Wait 2 seconds and then click the “**Search Servers**” button again to ensure the tET/tPET-P2R2 is working well with new configuration.
2. Click the “**Web**” button to link the tET/tPET-P2R2 web server.

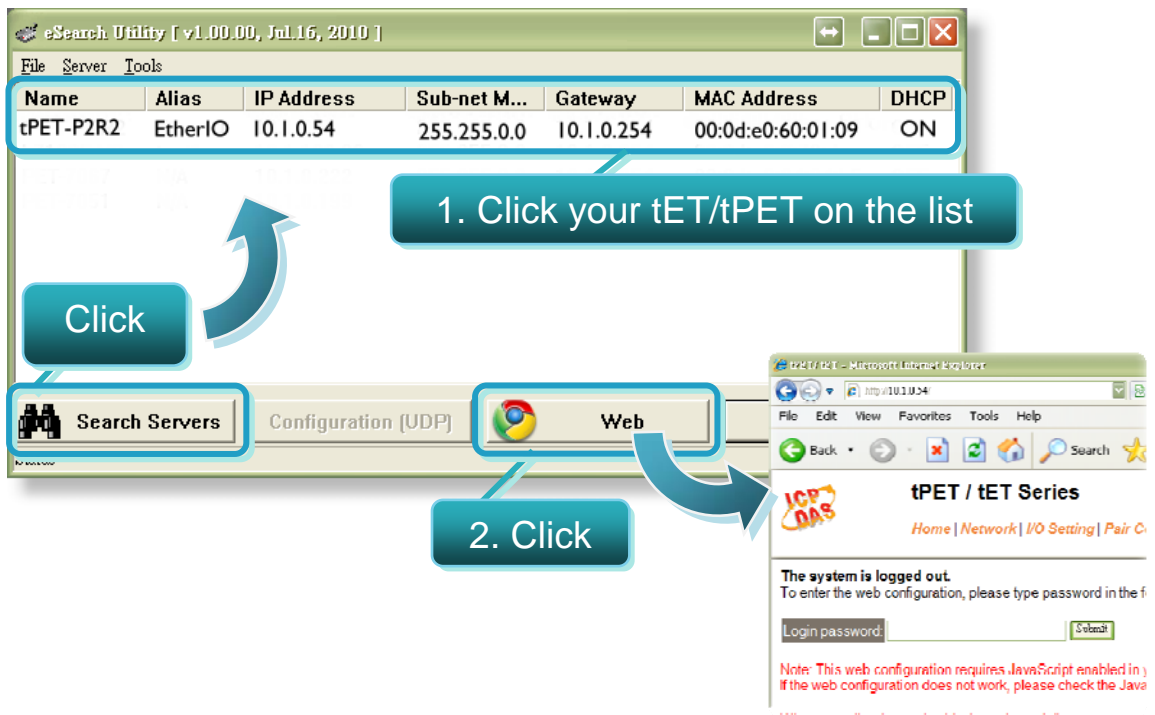

3. Enter the password and click the “**Submit**” button to enter the configuration web page. (The factory default password: **Admin**)

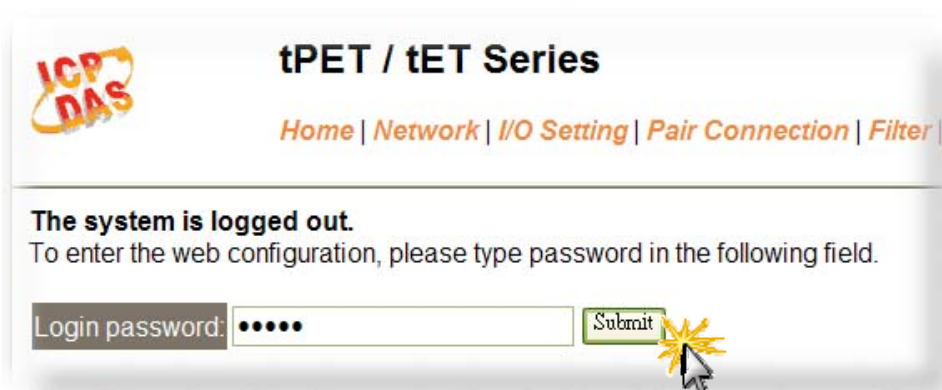

4. Control the I/O for simple test.

- In the **I/O Setting** page, check the **"bit0"** checkbox for setting **ON** to **DO0** and click **"Update Settings"** button.

- In the **Home** page, check that the **DO0** and **DIO** status should show current status are **"ON"**.

ALL DI:	Value	Digital Counter	High Latched	Low Latched
DI 0:	ON	0	X	X
DI 1:	OFF	0	X	X
DI 2:	-	-	-	-
DI 3:	-	-	-	-
DI 4:	-	-	-	-
DI 5:	-	-	-	-
DI 6:	-	-	-	-
DI 7:	-	-	-	-
DI 8:	-	-	-	-
DI 9:	-	-	-	-
DI 10:	-	-	-	-
DI 11:	-	-	-	-

DO7 - DO6 - DO5 - DO4 - DO3 - DO2 - DO1 OFF DO0 ON



Related Information

- **tET-P2R2/tPET-P2R2 Series Product Page:**
http://www.icpdas.com/products/Remote_IO/PETL7000/tPET-P2POR2.htm
- **tET/tPET Series Documentations:**
CD:\Napdos\tPET\document\
<http://ftp.icpdas.com/pub/cd/tinymodules/napdos/tPET/document/>
- **tET/tPET Series Firmware:**
CD:\Napdos\tPET\firmware\
<http://ftp.icpdas.com/pub/cd/tinymodules/napdos/tPET/firmware/>
- **NS-205, NS-205PES Product Page (optional):**
<http://www.icpdas.com/products/Switch/industrial/ns-205.htm>
<http://www.icpdas.com/products/Switch/industrial/ns-205pse.htm>

